

HARBOUR

12kg Top Load Washing Machine

INSTRUCTION MANUAL

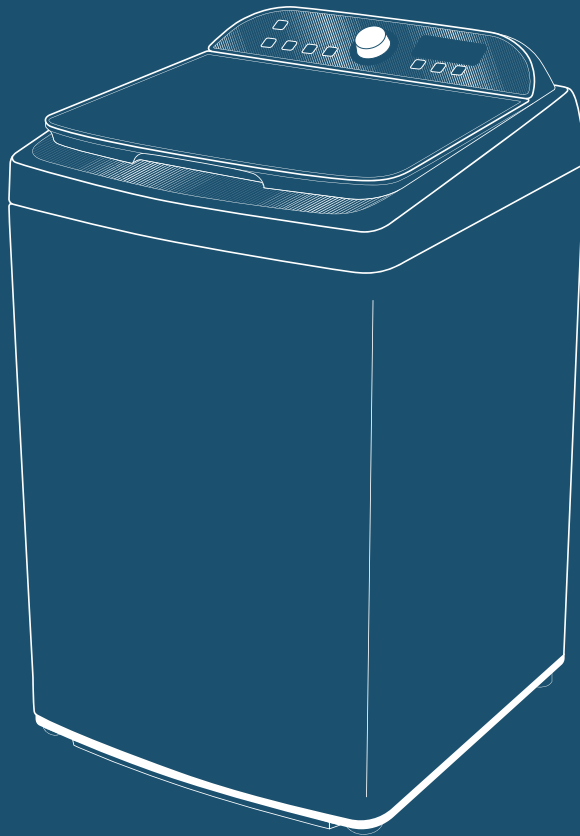

IM VERSION: V1.6 | MODEL: HBRTLWRC120W | PRODUCT CODE: 704357 | ISSUE DATE: 07/2021
SUPPORT: 1300 11 4357 | WWW.HARBOUR-APPLIANCES.COM.AU

Welcome

Congratulations on purchasing your new Washing Machine.

All products brought to you by Harbour are manufactured to the highest standards of performance and safety and, as part of our philosophy of customer service and satisfaction, are backed by our comprehensive 3 Year In Home Warranty. We hope you will enjoy using your purchase for many years to come.

Contents

- 2** Welcome
- 4** Warranty Details
- 5** General Safety Instructions
- 8** Product Overview
- 9** Installation Instructions
- 13** Operation Instructions
- 20** Maintenance and Cleaning
- 22** FAQs and Troubleshooting
- 25** Specifications
- 26** Repair and Refurbished Goods or Parts Notice
- 27** Warranty Returns



H A R B • U R

12kg Top Load Washing Machine

Warranty Details

REGISTER YOUR PURCHASE AT www.aldi.com.au/en/about-aldi/product-registration/ TO KEEP UP-TO-DATE WITH IMPORTANT PRODUCT INFORMATION

The product is guaranteed to be free from defects in workmanship and parts for a period of 36 months from the date of purchase. Defects that occur within this warranty period, under normal use and care, will be repaired, replaced or refunded at our discretion. The benefits conferred by this warranty are in addition to all rights and remedies in respect of the product that the consumer has under the Competition and Consumer Act 2010 and similar state and territory laws.

Our goods come with guarantees that cannot be excluded under the Australian Consumer Law. You are entitled to a replacement or refund for a major failure and for compensation for any other reasonably foreseeable loss or damage. You are also entitled to have the goods repaired or replaced if the goods fail to be of acceptable quality and the failure does not amount to a major failure.



General Safety Instructions

IMPORTANT SAFETY INSTRUCTIONS READ CAREFULLY AND KEEP FOR FUTURE REFERENCE

Read this manual thoroughly before first use, even if you are familiar with this type of product. The safety precautions enclosed herein reduce the risk of fire, electric shock and injury when correctly adhered to. Make sure you understand all instructions and warnings.

Keep the manual in a safe place for future reference, along with the completed warranty card and purchase receipt. If you sell or transfer ownership of this product, pass on these instructions to the new owner.

Always follow basic safety precautions and accident prevention measures when using an electrical appliance, including the following:

IMPORTANT: Pay particular attention to messages that contain the words **DANGER, WARNING or CAUTION**. These words are used to alert you to a potential hazard that can seriously injure you and others. The instructions will tell you how to reduce the chance of injury and let you know what can happen if the instructions are not followed.

USAGE CONDITIONS AND RESTRICTIONS

- **Domestic use only:** This appliance is intended for indoor household use only. It is not intended for commercial, industrial or outdoor use. It is not intended for use in a recreational vehicle.
- **Purpose:** Do not use this appliance for anything other than its intended purpose. Other uses are not recommended and may cause fire, electric shock or personal injury.
- **Attachments:** The use of attachments is not recommended by the appliance manufacturer and distributor as they may be hazardous.
- **Improper use:** Damage due to improper use, or repairs made by unqualified personnel will void your warranty. We assume no liability for any eventual damages caused by misuse of the product or noncompliance with these instructions.

This appliance is not intended for use by persons (including children) with reduced physical, sensory or mental capabilities or lack of experience and knowledge unless they have been given supervision or instruction concerning use of the appliance by a person responsible for their safety.

- Children should be supervised to ensure that they do not play with the appliance.
- If the supply cord is damaged, it must be replaced by the manufacturer, its service agent or similarly qualified persons in order to avoid a hazard.
- The new hose-sets supplied with the appliance are to be used and that old hose-sets should not be reused.
- The openings must not be obstructed by a carpet.
- This appliance is intended for indoor domestic (or household) use only, and is not intended for commercial, trade or industrial use.

Model:	HBRTLWRC120W
Washing Capacity:	12.0kg of dry clothes
Standard Water Pressure:	0.03-0.8MPa

GENERAL SAFETY INSTRUCTIONS CONT.

WARNING: POTENTIAL ELECTRIC SHOCK

- This appliance is for indoor use only.
- Do not position washing machine in a humid place.
- Do not insert your hands into running spin-dry tub.
- If the spin-dry tub does not stop within 15 seconds after opening the cover, please stop using the machine and have it repaired.
- Before performing any maintenance on the device, unplug the appliance from the mains.
- Always unplug the machine and turn off the water supply after use.
- The maximum inlet water pressure is 0.8MPa. The minimum inlet water pressure is 0.03MPa.
- To ensure your safety, power plug must be inserted into an earthed three-pole socket. Check carefully and make sure that your socket is properly and reliably earthed.
- Make sure that the water and electrical devices must be connected by a qualified technician in accordance with the manufacturer's instructions and local safety regulations.

WARNING: RISK TO CHILDREN

- The appliance can be used by children aged from 8 years and above and persons with reduced physical, sensory or mental capabilities or lack of experience and knowledge if they have been given supervision or instruction concerning use of the appliance in a safe way and understand the hazards involved. Children shall not play with the appliance. Cleaning and user maintenance shall not be made by children without supervision.
- Animals and children may climb into the machine. Check the machine before every operation.
- Young children should be supervised that they do not play with the appliance.
- Machine may be very hot during the operation. Keep kids and pets far away from the machine during the operation very wet rooms as well as in the rooms with explosive or caustic gas.
- **Remove all packaging before using the appliance. Otherwise, serious damage may result.**
- The washing machine with single inlet valve only can be connected to the cold water supply. The product with double inlet valves should be correctly connected to the hot water and cold water supply.
- Plug must be accessible after installation.

WARNING: RISK OF EXPLOSION

- Do not wash or dry articles that have been cleaned in, washed in, soaked in, or dabbed with combustible or explosive substances(such as wax, oil, paint, gasoline, degreasers, dry-cleaning solvents, kerosene, etc.) This may result in fire or explosion.
- Before hand thoroughly rinse items of washing by hand.

CAUTION: INSTALLING THE APPLIANCE

- This washing machine is for indoor use only.
- The appliance is not intended to for built-in use.
- The openings must not be obstructed by a carpet.
- Washing machine shall not be installed in bath room or very wet rooms as well as in the rooms with explosive or caustic gases.
- Remove all packaging and transport bolts before using the appliance. Otherwise, serious damage may result.
- Washing machines with single inlet valve only can be connected to the cold water supply. Models with double inlet valves should be correctly connected to the hot water and cold water supply.
- Both the cold and hot water inlet hoses must be connected. If you only use one hose, some water may be expressed through the other outlet.
- Plug must be accessible after installation.

GENERAL SAFETY INSTRUCTIONS CONT.

CAUTION: RISK OF DAMAGING THE APPLIANCE

- Your product is only for home use and is only designed for the textiles suitable for machine washing.
- Do not climb up and sit on top cover of the machine.
- Do not lean against machine door.
- Please do not close the door with excessive force.
- Do not wash carpets.

CAUTION: HANDLING THE APPLIANCE

- Transport bolts shall be reinstalled to the machine by a specialised person.
- The accumulated water shall be drained out of the machine.
- Handle the machine carefully. Never hold each protruded part on the machine while lifting.
- Machine door can not be used as the handle during the conveyance.
- This appliance is heavy. Transport with care.

CAUTION: OPERATING THE APPLIANCE

- Before washing the clothes at first time, the product should be operated in one round of the whole procedures without the clothes inside.
- Do not wash flammable and explosive or toxic solvents.
- Do not use gasoline and alcohol etc. as detergents.
- Please only select the detergents suitable for machine washing, especially for drum.
- Make sure that all pockets are emptied. Sharp and rigid items such as coin, brooch, nail, screw or stone etc. may cause serious damages to this machine.
- Please check whether the water inside the drum has been drained before opening its door. Please do not open the door if there is any water visible.
- Be careful of burning when the product drains hot washing water.
- Never refill the water by hand during washing.
- After the program is completed, please wait for two minutes to open the door.

RESPONSIBLE DISPOSAL

Note: At the end of its working life, do not throw this appliance out with your household rubbish. Electrical and electronic products contain substances that can have a detrimental effect on the environment and human health if disposed of inappropriately. Observe any local regulations regarding the disposal of electrical consumer goods and dispose of it appropriately for recycling. Contact your municipal authorities for advice on recycling facilities in your area. When the appliance is scrapped, disassemble the door to prevent entrapment of any children.



DISPOSAL: Do not dispose this product as unsorted municipal waste. Collection of such waste separately for special treatment is necessary.

This marking indicates that this product should not be disposed with other household wastes throughout the EU. To prevent possible harm to the environment or human health from uncontrolled waste disposal, recycle it responsibly to promote the sustainable reuse of material resources. To return your used device, please use the return and collection systems or contact the retailer where the product was purchased. They can take this product for environmental safe recycling.

For more detailed information about treatment, recovery and recycling of this product, please contact your local city office, your household waste disposal service or the shop where you purchased the product.

Product Overview

THE WASHING MACHINE

Note: The images in this user manual are for reference only. Your appliance may appear differently.

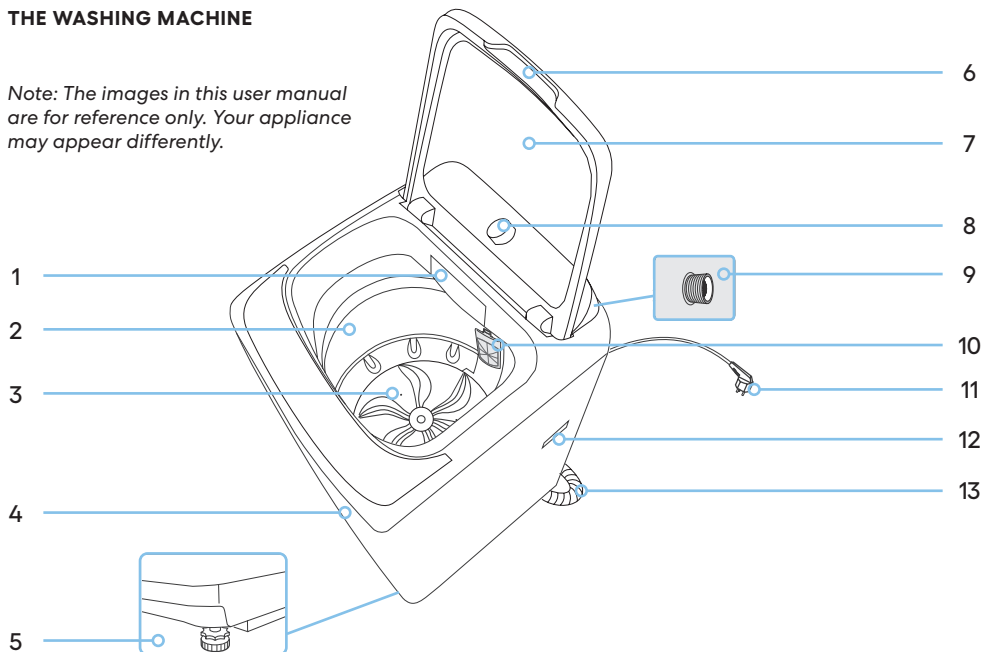

ACCESSORIES INCLUDED

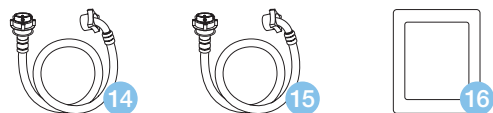

- Key:
1. Powder & liquid detergent box
 2. Wash & Spin barrel
 3. Impeller
 4. Cabinet exterior
 5. Adjustable feet
 6. Handle
 7. Glass lid
 8. Program dial
 9. Water inlet valve
 10. Filter holder

11. Power cord and plug
12. Cabinet handle
13. Drain hose
14. Supply hose (cold water)
15. Supply hose (hot water)
16. Cabinet baseboard

Not shown but also included:

- 1 × Instruction manual
- 1 × Quick start guide
- 1 × Warranty certificate

Installation Instructions

INSTALLATION INSTRUCTIONS

It's recommended to use the washing machine on its own dedicated power outlet for both convenience and safety. The power outlet must be grounded.

IMPORTANT

If the power cord (11) is damaged, it must be replaced by Residentia Group or one of its authorised service representatives.

Please contact 1300 11 HELP (4357) and ensure the appliance is completely disconnected from the power supply.

WARNING

Stability is important to prevent the product from moving!
Make sure that the product should not stand on the power cord (11).

Before installing the machine, the location must be:

- Rigid, dry, and a level surface
- Avoiding direct sunlight
- Sufficient ventilation
- Room temperature is above 0 °C
- Kept far away from the heat resources such as coal or gas.

UNPACKING THE WASHING MACHINE

WARNING

Packaging material (e.g. Films, Styrofoam) can be dangerous for children. There is a risk of suffocation! Keep all packaging well away from children.

- Remove the cardboard box and styrofoam packing.
- Lift the washing machine and remove the base packing.
- Remove the tape securing the power supply cord and drain hose.
- Remove the inlet hoses (14 & 15) from the drum.

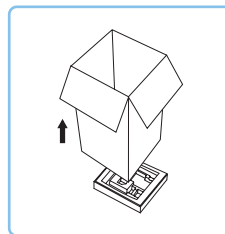
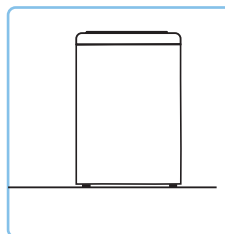
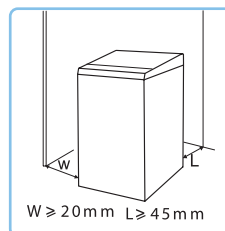

INSTALLATION INSTRUCTIONS CONT.

WARNING

To prevent leakage or water damage, follow the instructions in this chapter carefully:

- Do not kink, crush, modify, sever or protract the inlet hoses (14 & 15) or drain hose (13).
- Position drain hose properly, otherwise damage might result of water leakage.
- If drain hose is too long, do not force it into washing machine as it will cause abnormal noises.

There are two ways to place the end of drain hose:

1. For lower drain system

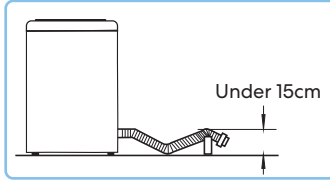
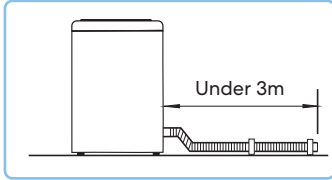

2. For upper drain system

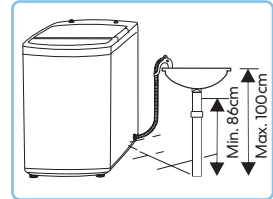
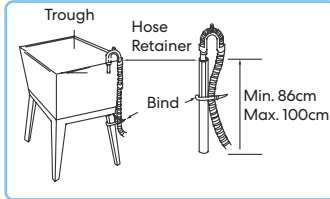
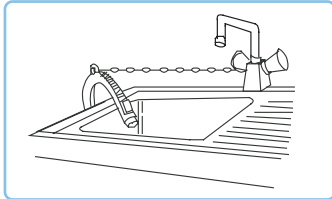

LEVELLING THE WASHING MACHINE

WARNING

The lock nuts on all four feet must be screwed tightly against the housing.

1. Check if the legs are closely attached to the cabinet. If not, please turn them to their original positions tighten the nuts.
2. Check alignment of the product with a spirit level and if required, correct.
3. Loosen the lock nut and turn the feet until it closely contacts with to the floor.
4. After being locked properly, press four corners again to make sure that they has been adjusted properly.

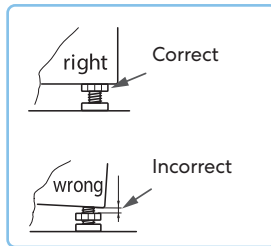
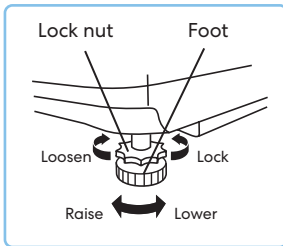

INSTALLATION INSTRUCTIONS CONT.

CONNECTION OF INLET HOSE, TAP AND WASHING MACHINE

Connection between screw tap and inlet hoses (14 & 15).

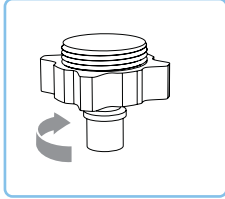

A. Ensure that clamp nut is loose and ready for connection

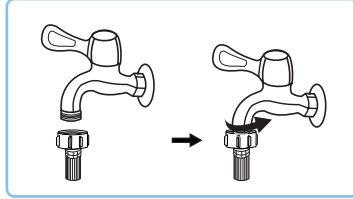

B. Tighten clamp nut on inlet hose to the screw tap faucet

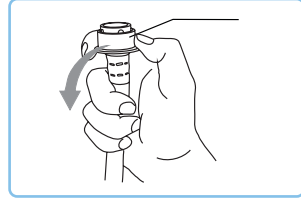

C. Press slide bushing, insert inlet hose into connecting base on water inlet valve

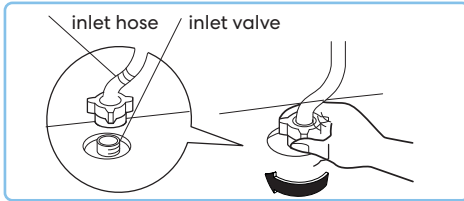

D. After connection and installation, check if there is water leakage

NOTE: To prevent leakage or water damage, follow the instructions in this chapter

CAUTION: Do not kink, crush, modify or sever the water inlet hoses (14 & 15).

This page
is intentionally
left blank

Operation Instructions

FIRST TIME USE

CAUTION

Prior to using the washing machine, ensure that it is correctly installed.

Before first use, the washing machine must perform one cycle without any clothes inside using the following steps:

- Connect the power source and water.
- Insert a small amount of detergent into the detergent drawer and close it.
- Power on the washing machine using the “On/Off” button.
- Turn the Program dial (8) to select any program. ‘Normal’ program is recommended.
- Press the “Start/Pause” button on the appliance.
- Allow the program to complete its full cycle.
- Your machine is now ready for use.

PREPARATION PROCEDURE FOR WASHING YOUR LAUNDRY

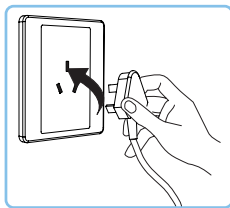

A. Plug in power

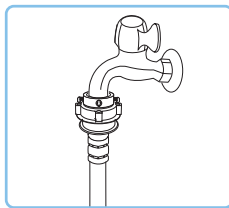

B. Open tap

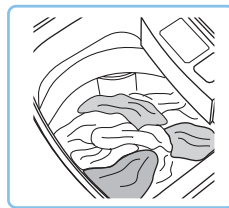

C. Load laundry items

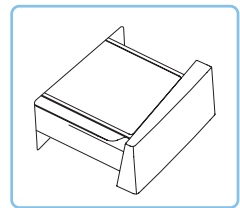

D. Add detergent and close lid

WASHING

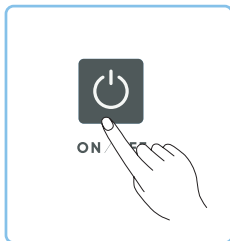

A. Power On

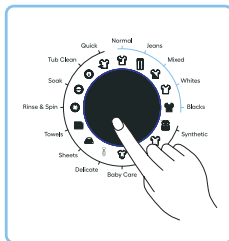

B. Select Program



C. Select Water Level

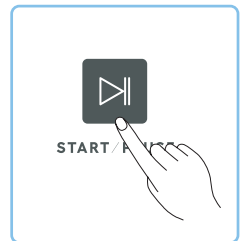

D. Start up

NOTE: If default is selected, step 2, 3 can be skipped.

AFTER WASHING

The appliance will sound an alert after washing cycle is complete and the power supply will be powered off automatically. Then unload the laundry.

OPERATION INSTRUCTIONS CONT.

THE CONTROLS

ON / OFF

Press this button to turn your washing machine **On** or **Off**.

ENHANCED CLEAN FUNCTION

Enhanced Clean can save between 20-40% of your cycle time by strengthening the washing beats.

This mode is available for the **Normal, Jeans, Mix Wash, Whites** and **Dark Wash** programs.

Press this button to activate and deactivate the Enhanced Clean function

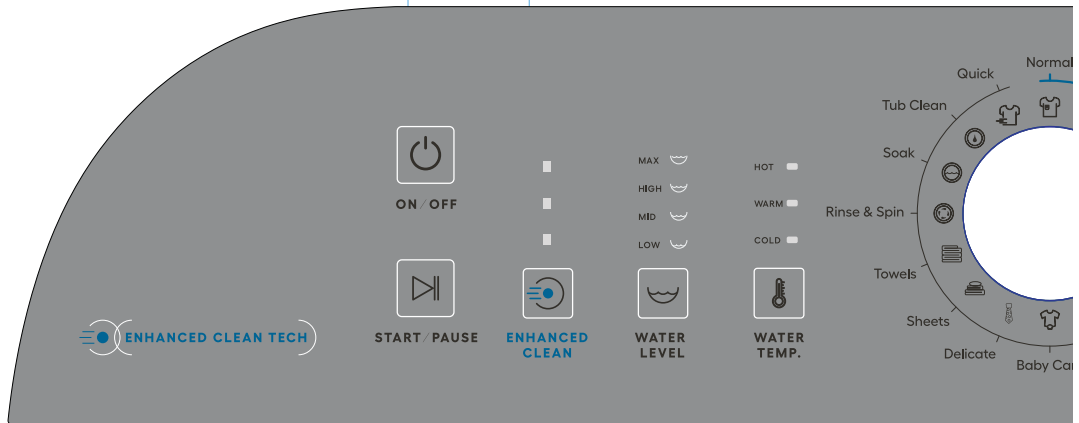

START/PAUSE

After selecting your desired wash settings, press this button to start your wash cycle.

You can also use this button to pause the washing machine during operation.

WATER LEVEL

Select this button to set your water level according to clothing categories, degree of soiling and washing habits of users.

WATER TEMPERATURE

Press this button to select your water temperature.

PROGRAM

Turn the Program dial to select your wash program type.

RINSE

Press this button to select your desired amount of times to rinse.

SPIN

Press this button to select your desired amount of times to spin.



DELAY

After choosing a Program, press the Delay button to choose a delayed start time. Press **Start/Pause** to commence the delay operation.

To switch the delayed start off, simply press the button until the delay light is off. If the program has already started, press the **Power** button to reset the program.

CHILD LOCK

Simultaneously press the **Rinse** and **Spin** buttons to activate the child lock. Repeat this process to deactivate the child lock.

NOTE!

- The Child Lock function will lock all buttons except **On / Off**.

OPERATION INSTRUCTIONS CONT.

WASHING CONSIDERATIONS

The working condition of the washer should be (0-40)°C. If used under 0°C, the inlet valve and draining system may be damaged. If the machine is placed under condition of 0°C or less, then it should be transferred to normal ambient temperature to ensure the water supply hose and drain hose are not frozen before use.

Please check the labels and the explanation of using detergent before wash.

Use non-foaming or less-foaming detergent suitable for machine washing properly.

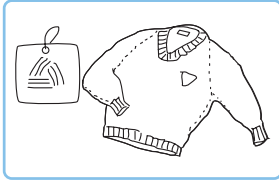

Check the label for washing advice

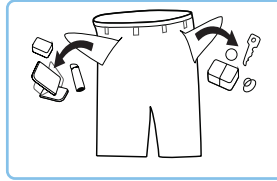

Take items out of the pockets

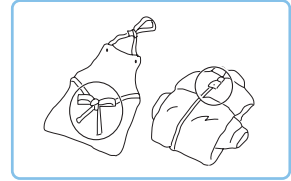

Knot long strings or ribbons, close zippers, and do up buttons

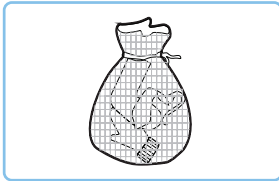

Put small clothes into a wash bag (not included)

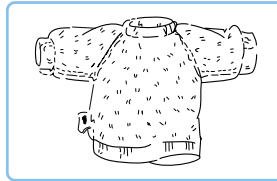

Turn easy-pilling and long-pile fabric inside out

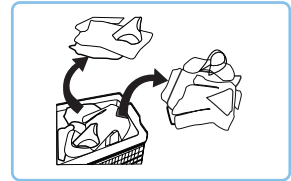

Separate clothes with different textures

NOTE:

- This machine features auto-unbalancing detection. Should the machine become unbalanced, it will sound an alert, and you will need to balance clothes in the drum by hand manually.
- When washing a single item, we recommend adding one or two more laundry items to your load to avoid the machine from being unbalanced, allowing for a smooth uninterrupted cycle and a smooth draining process.

WARNING

- Do not wash clothes that have come into contact with kerosene, gasoline, alcohol and other flammable materials.

THE USAGE OF DETERGENT AND WASHING POWDER

- Before machine washing powder or fabric softener is poured into the detergent box, we recommend that you use some water for dilution to prevent the inlet of the detergent box from being blocked and overflowing while filling water.
- Please choose suitable type of detergent for the various washing temperature to get the best washing performance with less water and energy consumption.

CAUTION

- When the lid is opened during machine operation, the alert will sound continuously.
If the lid is opened for more than 1 hour, the machine will shut down automatically.
- If there is any break in the power supply whilst the machine is in operation, a special memory stores the selected program when the power is restarted.

PERSONALISED WASH PROGRAM SETTING

Users can select washing program according to laundry needs, setting rinsing cycle amounts, water volume and delay time.

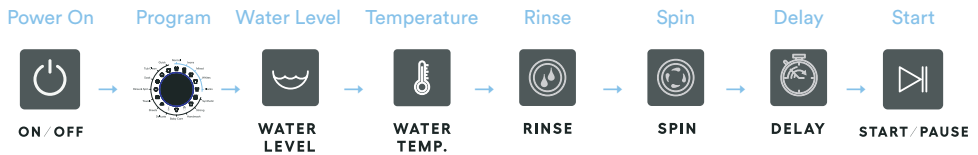

EXAMPLES OF WASHING CYCLES PROCESSES

Users can set single process or combinations of washing, rinsing and spinning freely according to demand. Detailed operations as follows:

SPIN ONLY FUNCTION



RINSE + SPIN FUNCTIONS



NOTE: There are other available process combinations not listed above.

OPERATION INSTRUCTIONS CONT.

WASHING PROGRAMS

NORMAL (STANDARD)

Standard fabric washing program, suitable to wash ramie cotton fabric. One wash cycle, two rinsing cycles and a longer spin time.

JEANS

Suitable for washing all types of denim.

MIX WASH

Suitable to wash a mix load of cotton and synthetic clothes.

WHITES

Suitable to wash white clothes.

DARK WASH

This wash cycle is suitable to wash dark garments protecting the colours better.

SYNTHETIC

This wash program is suitable to wash synthetic fabrics such as shirts and coats.

STRONG

The wash time is longer, the stream is stronger, so the washing effect is better.

HANDWASH

Protecting your clothes with a gentle wash program for hand-washable textiles.

BABY CARE

Suitable to wash children clothing.

DELICATE

This program has a gentle water flow. Suitable for washing woolen, thin or cleaner clothing.

SHEETS

Suitable to wash sheets.

TOWELS

Suitable to wash towels.

RINSE & SPIN

Extra rinse and spin.

SOAK

Suitable for more heavier soiled clothing. The wash program is like the Normal washing program but with a stronger water flow and an extra soak process lasting roughly 30 minutes before the wash process.

TUB CLEAN

It is recommended to run the Tub Clean program monthly to improve the quality of your washing outcome, water quality and drain flow. Tub Clean will target the washing powder residue inside and outside the barrel.

QUICK

Suitable to wash lightly dirty clothes with one rinsing cycle.

ENHANCED CLEAN FUNCTION

Enhanced Clean can save between 20-40% of your cycle time by strengthening the washing beats.

Start up Enhanced Clean: Power on, select "Normal", "Jeans", "Mix Wash", "Whites" or "Dark Wash" program, then press the Enhanced Clean button.

Cancellation of Enhanced Clean function:
The function can be cancelled by pressing the Enhanced Clean button or Power off.

FUZZY WEIGHTING

The washing machine will select the water level automatically according to the load weight.

- When there's water in the tub, this function is not available;
- Before press Start/Pause button, if consumer selected the water level, there will be no fuzzy weighting function;
- After press Start/Pause button, the washing machine will run the fuzzy weighting function. Consumer can also select the water level to set the water level as needed.

WASHING PROGRAMS TABLE

Program	Temperature	Water level	Soak	Wash time	Rinse cycles	Spin time (minutes)	Total time
Normal	Cold / Warm / Hot	Auto	—	0:26	0 / 1 / 2 / 3	0 / 5 / 7 / 9 / 11	1:18
Jeans	Cold / Warm / Hot	Auto	—	0:14	0 / 1 / 2 / 3	0 / 5 / 7 / 9 / 11	1:13
Mix Wash	Cold / Warm / Hot	Auto	—	0:14	0 / 1 / 2 / 3	0 / 5 / 7 / 9 / 11	1:11
Whites	Cold / Warm / Hot	Auto	—	0:18	0 / 1 / 2 / 3	0 / 5 / 7 / 9 / 11	1:13
Dark Wash	Cold / Warm	Auto	—	0:12	0 / 1 / 2 / 3	0 / 5 / 7 / 9 / 11	1:07
Synthetic	Cold / Warm / Hot	Low / Mid / High / Max	—	0:10	0 / 1 / 2 / 3	0 / 5 / 7 / 9 / 11	1:05
Strong	Cold / Warm / Hot	Low / Mid / High / Max	—	0:25	0 / 1 / 2 / 3	0 / 5 / 7 / 9 / 11	1:24
Handwash	Cold / Warm / Hot	Low / Mid / High / Max	—	0:14	0 / 1 / 2 / 3	0 / 5 / 7 / 9 / 11	1:09
Baby care	Cold / Warm / Hot	Low / Mid / High / Max	—	0:14	0 / 1 / 2 / 3	0 / 5 / 7 / 9 / 11	1:28
Delicate	Cold / Warm / Hot	Low / Mid / High / Max	—	0:12	0 / 1 / 2 / 3	0 / 5 / 7 / 9 / 11	1:07
Sheets	Cold / Warm / Hot	Low / Mid / High / Max	0:20	0:18	0 / 1 / 2 / 3	0 / 5 / 7 / 9 / 11	1:54
Towels	Cold / Warm / Hot	Low / Mid / High / Max	0:20	0:18	0 / 1 / 2 / 3	0 / 5 / 7 / 9 / 11	1:54
Rinse & Spin	Cold	Low / Mid / High / Max	—	—	0 / 1 / 2 / 3	0 / 5 / 7 / 9 / 11	0:28
Soak	Cold / Warm / Hot	Low / Mid / High / Max	0:30	0:12	0 / 1 / 2 / 3	0 / 5 / 7 / 9 / 11	1:39
Tub Clean	Cold	4	—	0:08	1	5	0:47
Quick	Cold / Warm / Hot	Low / Mid / High	—	0:06	1	5	0:35

NOTE:

- This product is subject to continuous improvement, specification are subject to change without prior notice.
- This product was tested in accordance with AS/NZS 2040.2 and AS/NZS6400 using program: 'Normal' and 'Max' water level, which is the program recommended for a normally soiled cotton load at rated capacity.
- The programs above are only recommendations and users can choose the appropriate program according to their personal requirements and habits.

Maintenance and Cleaning

CLEANING THE TUB

It is recommended to run the Tub Clean program monthly to improve the quality of your washing outcome, water quality and drain flow. Tub Clean will target the washing powder residue inside and outside the barrel. Turn the Program dial to Tub Clean when selecting your program cycle.

WARNING

Before you begin maintenance, please unplug the machine and close the tap.

CLEANING THE CABINET

Proper maintenance on the washing machine can extend its working life. The surface can be cleaned with diluted non-abrasive neutral detergents when necessary. If there is any water overflow, use the wet cloth to wipe it off immediately. No sharp items are allowed.

CAUTION

Formic acid and its diluted solvents or equivalent are forbidden, such as alcohol, solvents or chemical products, etc.

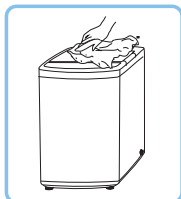

CLEANING THE INLET FILTER

CAUTION

Inlet filter must be cleaned if the water pressure is too low.

Washing the filter:

- Screw off the inlet pipe from the rear of the machine.
- Pull out the filter with long pliers.
- Use a brush to clean the filter.
- Reconnect the inlet pipe.
- Reinstall the filter to its original position after it has been washed.

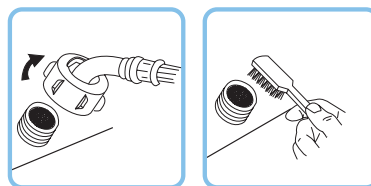

Lint filter clean:

- There is a built-in lint filter in your washing machine located at 10 in the Product Overview section. It can help to collect lint during washing cycles.
- We recommend cleaning the lint filter every 10 cycles.
- Take it out and clean the filter with water. Then place it back into the washer.



CLEANING THE DRAIN PUMP FILTER

WARNING

- Be careful of the hot water!
- Allow detergent solution to cool down.
- Unplug the machine to avoid electrical shock before washing.
- Drain pump filter can filter threads and small foreign matter from the washing.
- Clean the filter periodically to ensure the normal operation of washing machine.

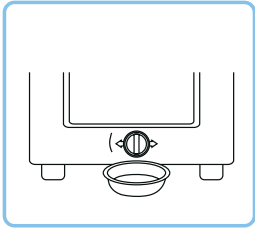

A. Drain the water out of the pump, using a container to collect it

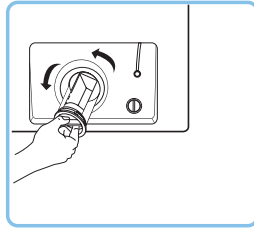

B. Open the filter by turning to the counter clockwise

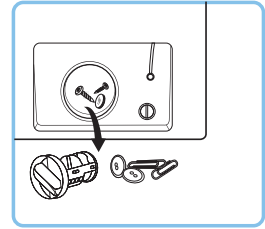

C. Remove foreign objects

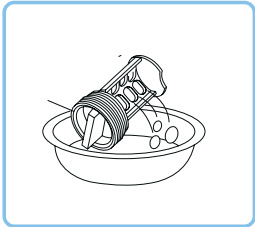

D. Clean the filter by running it under water

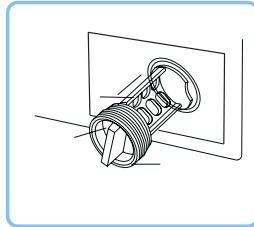

E. Slide the filter back into place to align at the pump hole

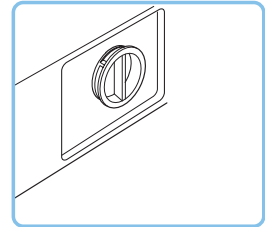

F. Tighten the pump cover clockwise until secure

CAUTION

- Ensure that the filter is installed back correctly otherwise water may leak.
- Some machines don't have an emergency drain hose, so step B and step C can be skipped. Rotate lower cover cap directly to make water run into basin.
- When the appliance is in use and depending on the program selected there can be hot water in the pump. Never remove the pump cover during a wash cycle, always wait until the appliance has finished the cycle, and is empty. When replacing the cover, ensure it is securely re-tightened.

FAQs and Troubleshooting

OPERATION IN CASE OF EMERGENCY

In the event of an emergency you should:

- Switch off all controls.
- Switch the washing machine off at the power point or at the fuse box.
- Call the Residentia Support Team on 1300 11 HELP (4357).

Some minor faults can be fixed by referring to the instructions given in the Troubleshooting section below. There is also a self-help section online at <https://support.residentiaigroup.com.au/>

Issue	Possible Causes
No washing	<ul style="list-style-type: none">• The power may be off or the fuse is burned out.• The power supply voltage may be too low.• The water amount does not reach to the required water level. (The washer will not work if the water amount does not reach the required water level)• The washer may be set to "Delay" washing mode. (It will only start to work until the reservation time reached)
No water flows in	<ul style="list-style-type: none">• The power may be off or the fuse is burned out.• The water supply is cut off or the water pressure too low.• The inlet hose may not be properly connected or the water tap is closed.• The filtering screen of inlet valve may be blocked by dirt.• The coil of inlet valve may be damaged. (The slight electromagnetic sound is normal phenomenon when the inlet valve is switched on)• The "Start / Pause" button might have been pressed after pressing the power "On/Off" button.
Abnormal draining	<ul style="list-style-type: none">• The water drain hose may be placed too high.• The end of water drain hose may be sealed in pond.• The internal rubber ring of drain valve may be blocked by dirt.
Abnormal spin	<ul style="list-style-type: none">• The door lid may not be fully closed.• The clothing may be piled largely at one side of barrel or the clothing is excessively placed.• The washer may not be placed in stable condition or it is placed in inclination state. (The ground is not flat).• The motor belt may be loose.

NOTE:

If checking any of the the above causes are not easily resolved or you cannot resolve the fault by yourself:

- Turn the washing machine off by pressing the "On/Off" button.
- Switch off the appliance at the power outlet and remove the plug.
- Call the Residentia Group support team on 1300 11 HELP (4357).

WARNING

Never dismantle the washing machine.

FAQS AND TROUBLESHOOTING CONT.

FAULT CODES AND POSSIBLE SOLUTIONS

If the washing machine experiences a fault, please contact the Residentia Group support team on 1300 11 HELP (4357).

WARNING

Never dismantle the washing machine.

Fault Code	Solution
E1	Error for abnormal water intake. Check if the water tap is open or closed.
E2	Error for water drain has not finished. Check the water level sensor and drain pump.
E3	Error for lid not closed before wash and spin. Close the lid.
E4	Error for laundry unbalancing the drum on one side. Manually balance clothes in the drum by hand.

If problems still occur, please contact the support team with the number at the top of this page.

This page
is intentionally
left blank

Specifications

Model:	HBRTLWRC120W
Rated Capacity:	12.0kg of dry clothes
Product Dimensions (W, D, H):	640mm, 684mm, 1085mm
Weight (Net/Gross):	53kg/58kg
Rated Input Power:	550W
Rated Voltage:	240V
Rated Frequency:	50Hz
Standard Water Pressure:	0.03-0.8MPa
Grade of Waterproof:	IPX4
Other Features:	16 Wash Programs
	Delay Start Function
	Water Level Adjustment
	Temperature Adjustment
	Enhanced Clean Function
	LED Display
	Child Lock
	Adjustable feet
	Auto-unbalancing detection
	Auto-power off
	Glass lid

NOTE:

This product is subject to continuous improvement, specification are subject to change without prior notice. This product was tested in accordance with AS/NZS 2040.2 and AS/NZS6400 using program: Standard, which is the program recommended for a normally soiled cotton load at rated capacity.

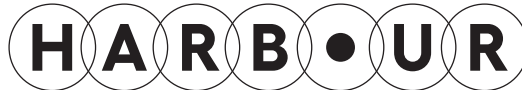

12kg Top Load Washing Machine

Repair and Refurbished Goods or Parts Notice

Unfortunately, from time to time, faulty products are manufactured which need to be returned to the Supplier for repair.

Please be aware that if your product is capable of retaining user-generated data (such as files stored on a computer hard drive, telephone numbers stored on a mobile telephone, songs stored on a portable media player, games saved on a games console or files stored on a USB memory stick) during the process of repair, some or all of your stored data may be lost.

We recommend you save this data elsewhere prior to sending the product for repair.

You should also be aware that rather than repairing goods, we may replace them with refurbished goods of the same type or use refurbished parts in the repair process.

Please be assured though, refurbished parts or replacements are only used where they meet ALDI's stringent quality specifications.

If at any time you feel your repair is being handled unsatisfactorily, you may escalate your complaint. Please telephone us on 1300 11 43 57 or write to us at:

165 Barkly Avenue,
Burnley VIC 3121
Australia

Email: support@residentiagroup.com.au

Helpline hours of operation:
Mon-Fri 9:00 AM - 5:00 PM





Warranty returns

Should you for any reason need to return this product for a warranty claim, make sure to include all accessories with the product.

Product does not work?

If you encounter problems with this product, or if it fails to perform to your expectations, make sure to contact our After Sales Support Centre on 1300 11 4357*

For an electronic copy of this manual, go to www.harbour-appliances.com.au and download a copy.

HARBOUR



E2447

AN INITIATIVE BY RESIDENTIA GROUP

TEL: 1300 11 4357 | EMAIL: SUPPORT@RESIDENTIAGROUP.COM.AU