

H A R B O U R

60cm 80L Electric Oven

INSTRUCTION MANUAL



IM VERSION: V1.7 | MODEL: HBROB605 | PRODUCT CODE: 708188 | ISSUE DATE: 03/2022

SUPPORT: 1300 11 4357 | WWW.HARBOUR-APPLIANCES.COM.AU

Welcome

Congratulations on purchasing your new Harbour Oven.

All products brought to you by Harbour are manufactured to the highest standards of performance and safety and, as part of our philosophy of customer service and satisfaction, are backed by our comprehensive 3 Year In Home Warranty. We hope you will enjoy using your purchase for many years to come.

Contents

- 02** Welcome
- 04** Warranty Details
- 05** General Safety Instructions
- 07** Product Overview
- 08** Oven Functions
- 09** Installation Instructions
- 11** Operation Instructions
- 12** Maintenance and Cleaning
- 14** Troubleshooting
- 16** Installation Certificate
- 17** Specifications
- 18** Repair and Refurbished Goods or Parts Notice
- 19** Warranty Returns



H A R B ● U R

60cm 80L Electric Oven

Warranty Details

REGISTER YOUR PURCHASE AT www.aldi.com.au/en/about-aldi/product-registration/ TO KEEP UP-TO-DATE WITH IMPORTANT PRODUCT INFORMATION

The product is guaranteed to be free from defects in workmanship and parts for a period of 36 months from the date of purchase. Defects that occur within this warranty period, under normal use and care, will be repaired, replaced or refunded at our discretion. The benefits conferred by this warranty are in addition to all rights and remedies in respect of the product that the consumer has under the Competition and Consumer Act 2010 and similar state and territory laws.

Our goods come with guarantees that cannot be excluded under the Australian Consumer Law. You are entitled to a replacement or refund for a major failure and for compensation for any other reasonably foreseeable loss or damage. You are also entitled to have the goods repaired or replaced if the goods fail to be of acceptable quality and the failure does not amount to a major failure.



General Safety Instructions

IMPORTANT SAFETY INSTRUCTIONS READ CAREFULLY AND KEEP FOR FUTURE REFERENCE

Read this manual thoroughly before first use, even if you are familiar with this type of product. The safety precautions enclosed herein reduce the risk of fire, electric shock and injury when correctly adhered to. Make sure you understand all instructions and warnings.

Keep the manual in a safe place for future reference, along with the completed warranty card and purchase receipt. If you sell or transfer ownership of this product, pass on these instructions to the new owner.

Always follow basic safety precautions and accident prevention measures when using an electrical appliance, including the following:

IMPORTANT: Pay particular attention to messages that contain the words **DANGER, WARNING** or **CAUTION**. These words are used to alert you to a potential hazard that can seriously injure you and others. The instructions will tell you how to reduce the chance of injury and let you know what can happen if the instructions are not followed.

USAGE CONDITIONS AND RESTRICTIONS

- **Domestic use only:** This appliance is intended for indoor household use only. It is not intended for commercial, industrial or outdoor use. It is not intended for use in a recreational vehicle.
- **Purpose:** Do not use this appliance for anything other than its intended purpose. Other uses are not recommended and may cause fire, electric shock or personal injury.
- **Attachments:** The use of attachments is not recommended by the appliance manufacturer and distributor as they may be hazardous.
- **Improper use:** Damage due to improper use or repairs made by unqualified personnel will void your warranty. The producer will assume no liability for any eventual damages caused by misuse of the product or noncompliance with these instructions.
- **IMPORTANT:** The appliance must be installed by an authorised technician. The producer is not responsible for any damage that might be caused by defective placement, and installation by unauthorised personnel.

WARNING:

- When the oven is first switched on, it may give off an unpleasant smell. This is due to the bonding agent used for the insulating panels within the oven.
- After the appliance has been properly installed, and before first use, you should burn off any dust, oil or other remnants that may have been left inside the cavity from the manufacturing process or transportation. Please run the new empty oven with the conventional cooking function at 250° C for at least 90 minutes.
- During the first use, it is completely normal that there will be a slight smoke and odors. If it does occur, you merely have wait for the smell to clear before putting food into the oven.
- The appliance and its accessible parts become hot during use. Care should be taken to avoid touching heating elements. Children less than 8 years of age shall be kept away unless continuously supervised.
- If the surface is cracked, switch off the appliance to avoid the possibility of electric shock.
- This appliance can be used by children aged from 8 years and above and persons with reduced physical, sensory or mental capabilities or lack of experience and knowledge if they have been given supervision or instruction concerning use of the appliance in a safe way and understand the hazards involved.
- Children shall not play with the appliance. Cleaning and user maintenance shall not be made by children without supervision.
- During use, the appliance becomes very hot. Care should be taken to avoid touching heating elements inside the oven.

GENERAL SAFETY INSTRUCTIONS CONT.

WARNING:

- Do not allow children to go near the oven when it is operating, especially when the grill is on.
- Ensure that the appliance is switched off and disconnected before replacing the oven lamp to avoid the possibility of electric shock.
- Children should be supervised to ensure that they do not play with the appliance.
- This appliance is not intended for use by persons (including children) with reduced physical, sensory or mental capabilities, or lack of experience and knowledge, unless they have been given supervision or instruction concerning use of the appliance by person responsible for their safety.
- If the supply cord is damaged, it must be replaced by the manufacturer, its service agent or similarly qualified persons in order to avoid a hazard.
- Do not use harsh abrasive cleaners or sharp metal scrapers to clean the oven door glass since they can scratch the surface, which may result in shattering of the glass.
- Excess spillage must be removed before cleaning.
- A steam cleaner is not to be used.
- The appliances are not intended to be operated by means of an external timer or separate remote control system.
- To ensure the oven shelves operate safely, correct placement of the shelves between the side rail is imperative. Please refer to page 9 for more information.
- The oven must not be installed behind a decorative door in order to avoid overheating.

SAFETY HINTS

- Do not use the oven unless you are wearing something on your feet. Do not touch the oven with wet or damp hands or feet.
- The oven door should not be opened often during the cooking period.
- When the door of oven is open do not leave anything on it, you may unbalance your appliance or break the door.
- Some parts of appliance may keep its heat for a long time; it is required to wait for it to cool down before touching onto the points that are exposed to the heat directly.
- If you will not use the appliance for a long time, it is advised to turn it off at the power source.

DECLARATION OF COMPLIANCE

When you have unpacked the oven, make sure that it has not been damaged in any way. If you have any doubts at all, do not use it: contact a professionally qualified person. Keep packing materials such as plastic bags, polystyrene, or nails out of the reach of children because these are dangerous to children.

Product Overview

YOUR OVEN

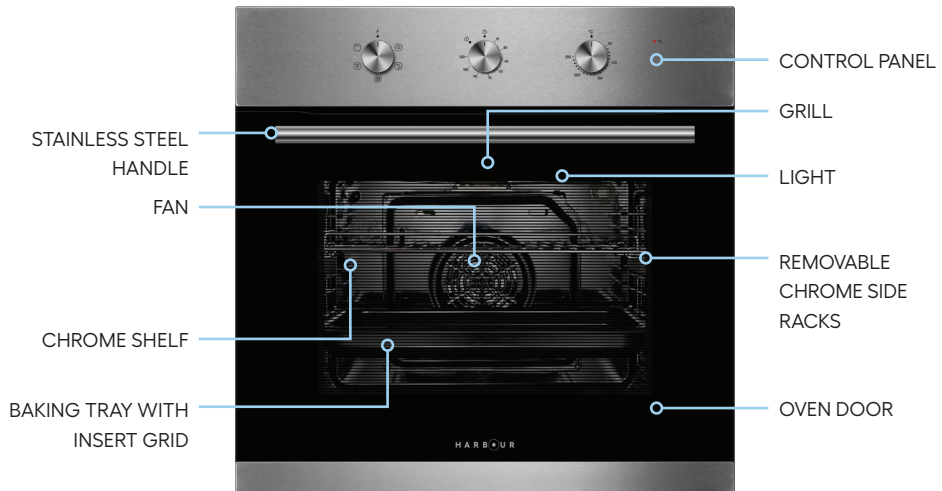



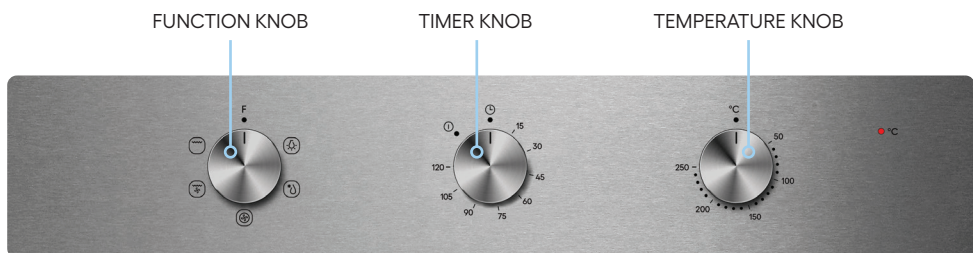

CONTROL PANEL



Note: The images in this user manual are for reference only. Your appliance may appear differently.

Oven Functions

OVEN FUNCTIONS

SYMBOL	FUNCTION DESCRIPTION
	Oven Lamp: Enables the user to observe the progress of cooking without opening the door. The oven lamp will light for all cooking functions.
	Defrost: The circulation of air at room temperature enables quicker thawing of frozen food (without the use of any heating elements). It is a gentle but quick way to speed up the defrosting time and thawing of ready-made dishes, cream-filled produce, etc.
	Grill: This cooking method is for everyday grilling, utilising only the inner grill element only, which directs heat downwards onto the food.
	Grill fan: The grill heating element and the fan operate, making it suitable for grilling a large amount of meat.
	Convection: Heat from the rear heating element circulated around the cavity by the fan. It is a fast and economical cooking function. This function also helps food cook faster whilst also reducing hot and cool spots and helping dishes on every shelf cook more evenly.

Installation Instructions

ACCESSORIES

WARNING: The appliance must be installed by an authorised technician and put into use. Damage due to improper use, or installation or repairs made by unqualified personnel will void your warranty. We assume no liability for any eventual damages caused by misuse of the product or noncompliance with these instructions.

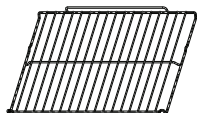

Wire Shelves

For grill, dishes, cake pan with items for roasting and grilling

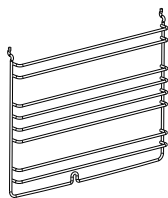

Side Racks

These shelf support rails on the right and left sides of the oven can be removed. Dishes and tray can be put on the oven floor, using functions as Grill or Double grill with fan.

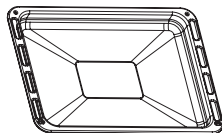

Baking tray

For cooking large quantities of food such as cakes, pastries, frozen food etc, or for collecting fat/spillage and meat juices.

SHELF PLACEMENT

To ensure the oven shelves operate safely, correct placement of the shelves between the side rail is imperative. Shelves and the pan only can be used between the first and fifth layers. The shelves should use with the right direction, it will ensure that during careful removal of the shelf or tray, hot food items should not slide out

INSTALLATION INSTRUCTIONS CONT.

INSTALLATION

FITTING THE OVEN INTO THE KITCHEN UNIT

Fit the oven into the space provided in the kitchen unit; it may be fitted underneath a work top or into an upright cupboard. Fix the oven in position by screwing into place, using the two fixing holes in the frame. To locate the fixing holes, open the oven door and look inside. To allow adequate ventilation, the measurements and distances adhered to when fixing the oven.

IMPORTANT

If the oven is to work properly, the kitchen housing must be suitable. The panels of the kitchen unit that are next to the oven must be made of a heat resistant material. Ensure that the glues of units that are made of veneered wood can withstand temperatures of at least 120° C. Plastics or glues that cannot withstand such temperatures will melt and deform the unit, once the oven has been lodged inside the units, electrical parts must be completely insulated. This is a legal safety requirement. All guards must be firmly fixed into place so that it is impossible to remove them without using special tools. Remove the back of the kitchen unit to ensure an adequate current of air circulates around the oven. The hob must have a rear gap of at least 45mm.

Note: The cavity is not to include the power switch or socket.

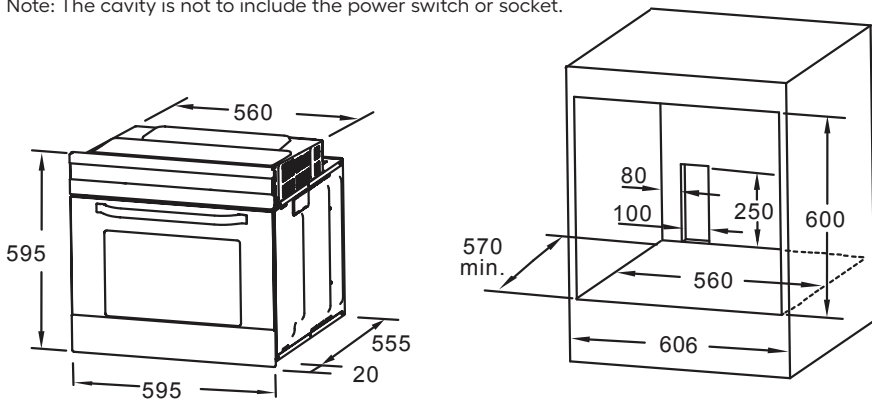

SECURING THE OVEN TO THE CABINET

1. Fit oven into the cabinet recess.
2. Open the oven door.
3. Secure the oven to the kitchen cabinet with the two distance holders "A" which fit the holes in the oven frame and fit the two screws "B".

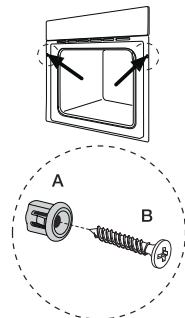

VENTILATION

When cooking is finished, in pause state or in waiting state and if the oven's center temperature is over 75 degrees the cooling fan will continue working for 15 minutes. Or when the oven's center temperature becomes lower than 75 degree, the cooling fan will stop in advance.

Operation Instructions

BEFORE FIRST USE

- **Read:** Before using the oven for the first time, read this manual thoroughly, even if you are familiar with this type of appliance. Pay particular attention to the safety instructions on pages 5–6. Refer to pages 8–11 for a product overview, oven functions and installation instructions.
- **Initial use:** After the appliance has been properly installed, and before first use, you should burn off any dust, oil or other remnants that may have been left inside the cavity from the manufacturing process or transportation. Please run the new empty oven with the conventional cooking function at 250° C for at least 90 minutes.

USING YOUR OVEN WITHOUT A TIMER

1. If you want to set a timer refer to the next section 'USING YOUR OVEN WITH A TIMER', otherwise rotate the timer knob counter clockwise to the **⓪** symbol to operate the oven without a timer. This will stop the oven from automatically powering off while in the upwards position.
2. Then turn the temperature knob and the function knob to your desired settings.
3. Once you have finished cooking turn all knobs back to their original position, facing upward, to turn the oven off.

USING YOUR OVEN WITH A TIMER

Use the timer control knob to set the oven to power off after your set number of minutes. Follow these steps to operate the oven in timer mode.

1. Rotate the timer knob clockwise to set your desired number of minutes, between 15 and 120 minutes.
2. Then turn the temperature knob and the function knob to your desired settings.
3. Once the timer is up the oven will make a sound to indicate that cooking is complete and the oven will automatically power off.

Maintenance and Cleaning

For the sake of a good appearance and reliability, keep the unit clean. The modern design of the unit facilitates maintenance to a minimum. The parts of the unit which come into contact with food have to be cleaned regularly.

- Before any maintenance and cleaning, disconnect the power.
- Set all controls in the OFF position.
- Wait until the inside of the unit is not hot but only slightly warm—cleaning is easier than when warm.
- Clean the surface of the unit with a damp cloth, soft brush or fine sponge and then wipe dry.
- In case of heavy soiling, use hot water with non-abrasive cleaning product.
- For cleaning the oven door glass, do not use abrasive cleaners or sharp metal scrapers, as these can scratch the surface or lead to the glass being damaged.
- Never leave acidic substances (lemon juice, vinegar) on stainless steel parts.
- Do not use a high pressure cleaner for cleaning the unit.
- The baking tray and wire shelving may be washed in mild detergent.

BULB REPLACEMENT

For replacement, follow the below process:

1. Disconnect power from the mains outlet or switch off the circuit breaker of the unit's mains outlet.
2. Unscrew the glass lamp cover by turning it counter-clockwise (note, it may be stiff) and replace the bulb with a new one of the same type.
3. Screw the glass lamp cover back in place.

NOTE: Only use 25-40W/220V-240V , T300°C halogen lamps.

REMOVING THE OVEN DOOR

The removable door allows for full access to the entire interior of the oven for easier and quicker maintenance. Follow these instructions carefully if you wish to remove the oven door.

1. To remove the door, open the door to the maximum angle. Then pull the buckle at the door hinge backward.

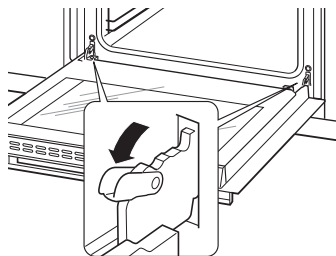

2. Close the door to an angle approximately 30°. Hold the door with one hand on each side. Lift up and slowly pull the door out from the oven.

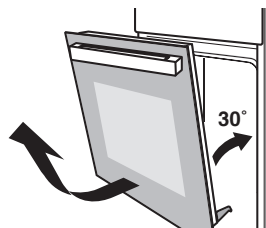

MAINTENANCE AND CLEANING CONT.

3. Open the door rotation bracket assembly.

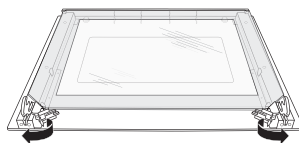

4. Place the door on a flat surface with the handle side down and lift up the glass panel to pull it out. Then take the middle glass panel out in the same way.

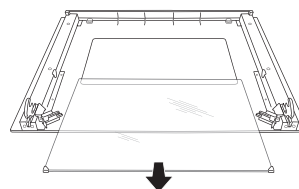
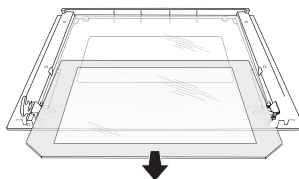

WARNING:

- Do not forcefully pull out the door to prevent the glass from breaking during the dismantling process.
- The hinge springs could come loose and cause personal injury.
- Do not lift or carry the oven door by the door handle.



DISPOSAL: Do not dispose this product as unsorted municipal waste. Collection of such waste separately for special treatment is necessary.

This appliance is marked according to the European directive 2012/19/EU on Waste Electrical and Electronic Equipment (WEEE).

By ensuring this product is disposed correctly, you will help prevent potential negative consequences for the environment and human health, which could otherwise be caused by inappropriate waste handling of this product. The symbol on the product indicates that this product may not be treated as household waste. Instead it shall be handed over to the applicable collection point for the recycling of electrical and electronic equipment. Disposal must be carried out in accordance with local environmental regulations for waste disposal. For more detailed information about treatment, recovery and recycling of this product, please contact your local city office, your household waste disposal service or the shop where you purchased the product.

Troubleshooting

In the event of an emergency you should:

- Turn the cooktop off.
- Switch off the appliance at the power outlet and remove the plug.
- Call the Residentia Group support team on 1300 11 HELP (4357).

Ensure that you have read and adhered to all information in this instruction manual.

Some minor faults can be fixed by referring to the instructions given in the Troubleshooting section below. There is also a self-help section online at <https://support.residentiagroup.com.au/>

Some minor faults can be fixed by referring to the instructions given in the table below:

Issue	Possible Cause	Resolution
The oven is not turning on.	Break in power supply.	<ul style="list-style-type: none">• Check the oven is plugged in and the power is on.• Check the household fuse box for any blown fuses and replace as necessary. Also ensure that a safety switch hasn't tripped.
The oven light is not working.	The light globe is loose or has blown.	<ul style="list-style-type: none">• When the oven has cooled and is switched off, remove the globe cover and ensure that the globe is tight.• If blown, refer to the Cleaning and Maintenance section under Bulb Replacement.
The oven is burning the top of my dish whilst the underside is under-done.	Not enough heat from the bottom of the oven.	<ul style="list-style-type: none">• Try using the Conventional cooking functions.• Try lowering the temperature.• Try using a lower shelf position.
The oven is burning the underside of my dish whilst the top is under-done.	Excessive heat from the bottom of the oven.	<ul style="list-style-type: none">• Try using the Conventional cooking functions.• Try lowering the temperature.• Try using a higher shelf position.
The oven is burning the outside of my dish whilst the inside is under-done.	Temperature is set too high.	<ul style="list-style-type: none">• Lower the temperature and increase the cooking
The outside of my dish is too dry even though it looks cooked.	Temperature is set too low.	<ul style="list-style-type: none">• Increase the temperature and decrease the cooking duration.

For further care instructions and troubleshooting tips visit our website www.harbour-appliances.com.au.

If you need to speak to someone please contact our after sales support centre on 1300 11 43 57 for any assistance.

**THIS PAGE IS
INTENTIONALLY LEFT BLANK**

Installation Certificate

CUSTOMER TO NOTE

IMPORTANT: You Harbour 60cm 80L Electric Oven must be installed by a licensed electrician. Improperly installed appliances can be dangerous and/or expensive to repair. Please never try to modify or repair the appliance by yourself.

The details below are to be completed by the installer. Please retain your user manual with this filled-out page, along with the original purchase invoice and the Certificate of Safety (as provided by the installer) in the event that you need warranty support in future.

INSTALLATION

DATE OF INSTALLATION |

PRODUCT SERIAL NUMBER |

CUSTOMER NAME |

INSTALLATION ADDRESS |

INSTALLER DETAILS

FULL NAME |

LICENCE NUMBER |

SIGNATURE |

CUSTOMER TO RETAIN THIS PAGE

Specifications

Model:	HBROB605
Gross Volume:	80L
Product Dimensions (W × D × H):	595 × 575 × 595mm
Weight (Net/Gross):	30.2kg/33.2kg
Rated Voltage	220-240V~
Rated Frequency	50Hz-60Hz
Rated Power	2.1kW
No. of Functions	5
Other Features:	Minute Minder Timer
	Triple Glazed Door
	Fixed Knob Controls
	Stainless Steel handle
	Removable Chrome Side Racks
	1 × Chrome wire shelf
	1 × Baking tray with chrome rack insert
	10 Amp plug

NOTE:

This product is subject to continuous improvement, specifications are subject to change without prior notice.
This product was tested in accordance with the following standard:
AS/NZS 60335.2.6:2014+A1 & AS/NZS 60335-1: 2020



H A R B O U R

60cm 80L Electric Oven

Repair and Refurbished Goods or Parts Notice

Unfortunately, from time to time, faulty products are manufactured which need to be returned to the Supplier for repair.

Please be aware that if your product is capable of retaining user-generated data (such as files stored on a computer hard drive, telephone numbers stored on a mobile telephone, songs stored on a portable media player, games saved on a games console or files stored on a USB memory stick) during the process of repair, some or all of your stored data may be lost.

We recommend you save this data elsewhere prior to sending the product for repair.

You should also be aware that rather than repairing goods, we may replace them with refurbished goods of the same type or use refurbished parts in the repair process.

Please be assured though, refurbished parts or replacements are only used where they meet ALDI's stringent quality specifications.

If at any time you feel your repair is being handled unsatisfactorily, you may escalate your complaint. Please telephone us on 1300 11 43 57 or write to us at:

Residentia Group
165 Barkly Avenue
Burnley VIC 3121
Australia

Email: support@residentiagroup.com.au

Helpline hours of operation:
Mon–Fri
9:00 AM - 5:00 PM





Warranty returns

Should you for any reason need to return this product for a warranty claim, make sure to include all accessories with the product.

Product does not work?

If you encounter problems with this product, or if it fails to perform to your expectations, make sure to contact our After Sales Support Centre on 1300 11 4357.

For an electronic copy of this manual, go to www.harbour-appliances.com.au and download a copy.

H A R B O U R



E2447

CERTIFICATE NO.: SGS-170971-EA

AN INITIATIVE BY RESIDENTIA GROUP

TEL: 1300 11 4357 | EMAIL: SUPPORT@RESIDENTIAGROUP.COM.AU